



# Solutions for photovoltaic systems

Installation, protection and cable routing for pitched-roof, flat-roof or free-standing systems

# Building Connections



OBO Bettermann has offered innovative products and matching solutions for electrical installation for over 100 years. Our focus has always been on protective installations for the reliable protection of buildings, people and property. With our many years of experience and our comprehensive product range, we are one of the leading manufacturers in this area.

OBO's special spirit of innovation flows into each of our currently more than 30,000 products – the guarantee of continuous further development, even in the future. Our partnership with our customers is crucial for this further development. If you have any questions about products, mounting or planning, OBO employees will be happy to provide you with expert support at every stage of your project. This means that you are always on the safe side.



## OBO Academy: From the basic principles to real-life applications

For many years, the OBO Academy has offered a comprehensive portfolio of seminars. "Advantage through knowledge" is not just a slogan here, but a promise: With first-hand information, a link to practical situations and expert knowledge, we can offer participants a decisive knowledge advantage. In our seminars, planner days or online seminars, we will bring you up to speed with current developments, trends, standards and regulations.

The OBO Academy can also offer a special training course on the protection of photovoltaic systems (PV systems). Here, you can find out how to best protect your PV system against surge voltages, have the opportunity to ask any questions you have on the subject and will also receive additional information material for reference.



## OBO Support: A plus for you

Every OBO product carries a plus inside it, which only one brand can offer. It is developed, manufactured and tested with a high level of competence, from the idea through to the final check. From flawless logistics through to practical information – we can provide support at every level. We can offer additional security through certificates on the conformity of our products with the most important standards and directives.



# Solar – so good! Comprehensive expertise in photovoltaic systems

The procurement of a PV system is always connected with high levels of investment, which should prove its worth as quickly as possible. This makes its continuous availability that much more important. As PV systems are installed on a roof or in an open location, they are particularly susceptible to lightning strikes and surge voltages. With OBO, you are always on the safe side! We offer you a complete system that fulfils almost all the electrical requirements of a PV system.

## Solutions with a system

In this brochure, we want to present our solutions for a permanently safe and quick installation. You can also find answers to a wide range of questions pertaining to the protection and supply of PV systems.

- Can the OBO mounting systems be adapted to different installation conditions?
- How do I install external lightning protection in combination with a PV system?
- How do I maintain the required separation distances to the lightning protection system?
- How do I best protect the inverter?
- What options do I have for strain relief of vertical cable routing?
- How do I route cables in the area of emergency and escape routes?

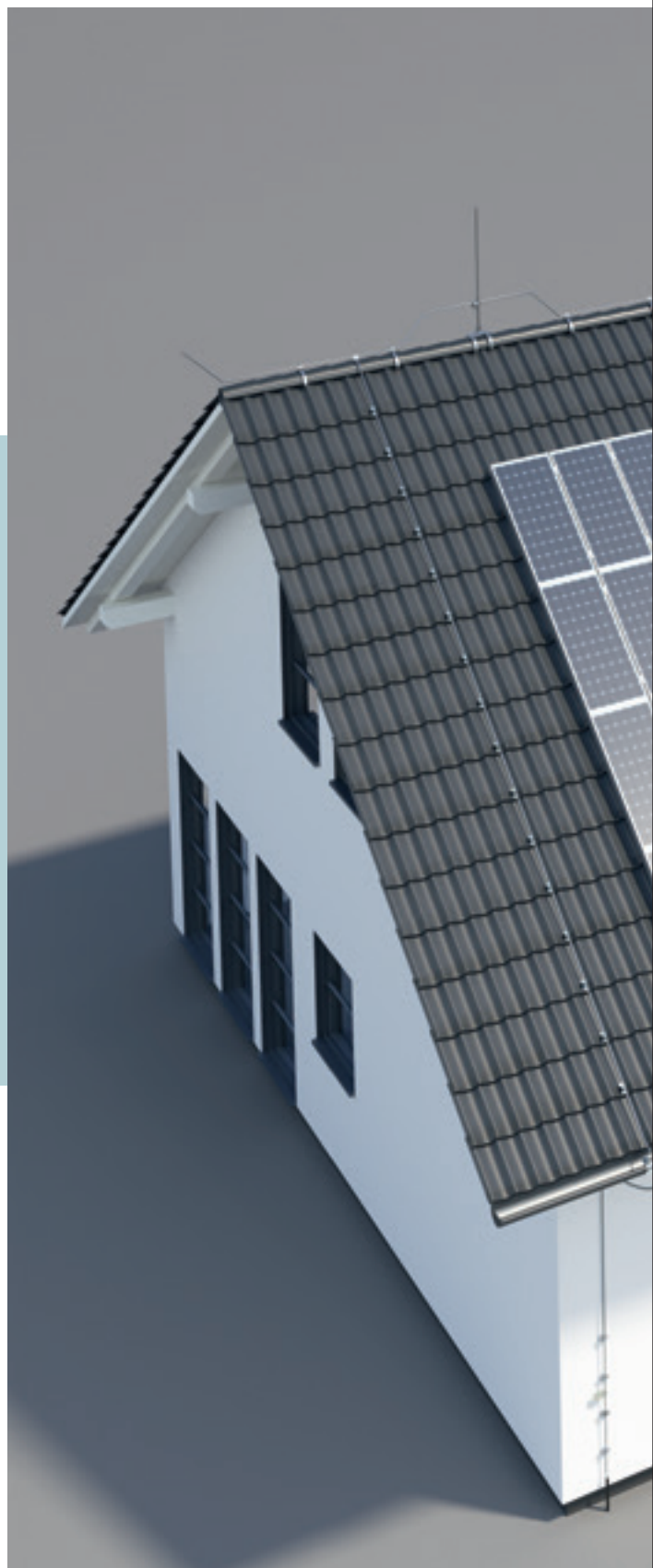



## Mounting systems

Page 08

## External lightning protection

Page 12

## Surge protection

Page 22

## Earthing systems

Page 24

## Equipotential bonding

Page 26

## Cable routing

Page 30

## Structural fire protection

Page 34



Please note: This icon indicates pages with more detailed information on the planning and installation of PV systems.

# Taking responsibility, protecting the system

The erection of a lightning protection system often requires major intervention in the electrical infrastructure of a building. This is reflected in the wide range of standards and regulations to be complied with in this area. The person erecting the system is liable for correct fulfilment for 30 years, and the requirements of the insurance company come on top of that. The specialist company installing an electrical system is required by law to hand it over in perfect condition. According to the low-voltage connection ordinance (NAV), the electrician listed in the energy supplier's installer list may only connect tested and correct systems to the public power grid.

## Responsibility of the operator

Through the feed-in of the gained energy, almost every PV system is subject to the requirements for commercial use. For the system operator, this creates the obligation, according to the accident prevention requirement BGV A3, to give the system the proper maintenance, checking and repairs. These regular recurring checks of the electrical system components must be carried out by an electrical technician.

*The overall responsibility for electrical safety is in the hands of the commissioner.*

#### **Photovoltaics working party**

*People, animals and property must be protected against damage from surge voltages, the consequences of atmospheric impacts or switching surges.*

**VDE 0100-100 (IEC 60364-1)**

”

## **Relevant standards:**

### **Erection of low-voltage electrical installations**

- DIN VDE 0100-100 (IEC 60364-1)
- DIN VDE 0100-534 (IEC 60364-5-53)
- DIN VDE 0100-410 (IEC 60364-4-41)
- DIN VDE 0100-443 (IEC 60364-4-44)
- DIN EN 60664-1 (IEC 60664-1)

### **Tests (commissioning test) and documentation**

- VDE 0100-600 (IEC 60364-6)
- VDE 0105-100 (EN 50110-1)

### **Requirements for PV power supply systems**

- DIN VDE 0100-712 (IEC 60364-7-712)
- DIN EN 62446 (IEC 62446)
- DIN CLC/TS 61643-12 (IEC 61643-12)
- DIN CLC/TS 50539-12 (CLC/TS 51643-32, IEC 61643-32)
- VDE 0185-305-3 Supplement 5

### **Lightning protection systems and earthing systems**

- DIN EN 62305-1 to -4 (IEC 62305-1 to -4)
- Local additional requirements (e.g. state building regulations in Germany)
- DIN 18014
- DIN VDE 0100-540 (IEC 60364-5-54)

### **Fire protection in the PV areas**

- VDE-AR-E 2100-712

### **Construction regulations**

- EN 13501-1/-2, DIN 4102-1/-2 Fire classification of construction products and building elements
- The national and regional construction regulations must be observed with regard to the use of construction products. These include, for example, the state construction regulations in Germany, VKF regulations in Switzerland and OIB directives in Austria.

*This list makes no claim to completeness! Please observe the appropriate local and statutory requirements.*

# Install the future!



With OBO, you are on the (b)right side from the start: This is because we not only offer you a complete system for almost every electrical requirement of a photovoltaic system, but also future-oriented solutions for flexible installations. Leading the way are our innovative mounting systems for pitched roofs, flat roofs and free-standing systems: the Magic PV solution. For more efficiency: Solar so good!



## The benefits of the Magic PV solution

- Less work: A slim overall portfolio offers a simplified product selection and reduces warehouse storage to a minimum.
- More flexibility: With the Magic PV solution, countless customer-specific solutions and structural implementation options can be achieved.
- More security: Correct installation of all standard PV module dimensions is very simple.
- Versatile: The OBO systems can be adapted to different installation conditions with ease.
- More future: Digital planning tools and an innovative product configurator provide support in advising your customers.



## Fitting systems for pitched roofs

Most pitched-roof systems are mounted on existing building roofs as so-called on-roof systems. Most pitched-roof systems are mounted on the roofs of existing buildings as so-called on-roof systems. Here, the PV modules are attached to the roof itself, using roof hooks. The roof hook in turn is attached to the roof structure and holds the mounting rail for the module clamp.

- Magic technology: Allows screwless and toolless mounting, thus providing time savings.
- Roof hook solution: Can be mounted on all standard pitched-roof types with tiled roofing and adjusted continuously and down to the millimetre in all directions at any time.
- Universal clamp: Simultaneously functions as an connection or end clamp, covering a clamping range of 30–50 mm. For easy fixing of all standard PV modules.
- Support profile and universal clamp available in a black version – for a seamless, attractive appearance



## Fitting system for flat roofs

- Magic technology: Allows screwless and toolless mounting, thus providing time savings.
- UniBase ballast system: For variable weighing down of the overall system using rectangular blocks – even at any time after installation! Can also be combined with other OBO products, as required, e.g. with the roof conductor holder, type 165 MBG.
- Universal clamp: Simultaneously functions as an connection or end clamp, covering a clamping range of 30–50 mm. For easy fixing of all standard PV modules.
- For a complete solution from a single source: Easily combined with OBO lightning and fire protection systems. Cable routing systems can also be integrated into the overall system.



### Fewer components, less work.

The products for flat and pitched-roof systems can be combined. This considerably reduces the number of individual components required.

## Installation system for free-standing systems

Free-standing photovoltaics means the erection of PV modules on large areas predominantly not used for agriculture. Under favourable conditions, these photovoltaic systems can produce increased yields.

- The highest level of flexibility: Both rammed and anchored versions are available.
- Little installation work: We can offer you system components pre-mounted at the factory.
- Maximum installation options: Different profile lengths and flexible perforations enable almost any installation. Besides the intended OBO terminals, standard fastening materials, such as standard bolts, can also be used.



# External lightning protection for roof systems



The inclusion of a PV system into the existing lightning protection concept of a building is often neglected during refitting work. This significantly increases the risk of considerable damage through a direct lightning strike.

For public buildings or customised structures, for example, the LBO (state construction regulations) require a lightning protection system as fire and personal protection.

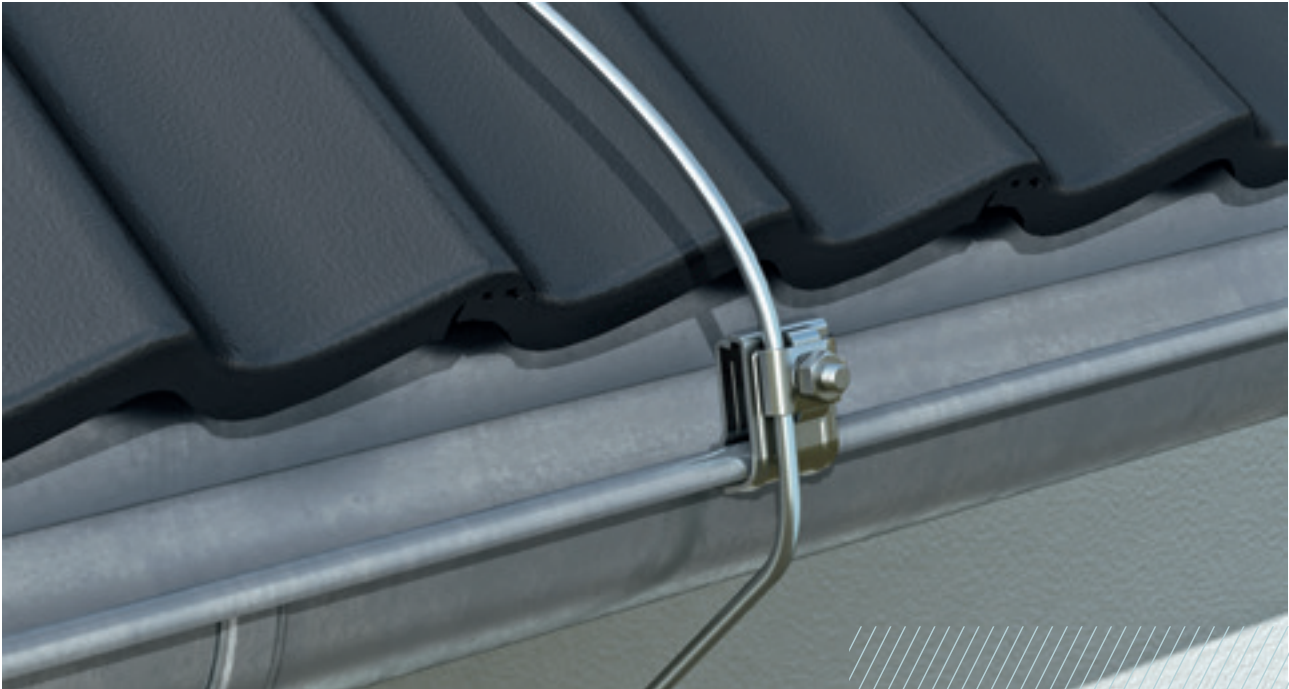

## Complete product range, decades of experience

Our comprehensive product range, tested in the OBO BET laboratory, and our experience mean that we can offer the right solutions for almost any type of system. Lightning strikes are intercepted safely and run to the earth in a controlled manner with the following OBO systems:

- Air-termination rods
- Rod holders
- Ridge conductor holders
- Roof conductor holder for ridge tiles
- Roof conductor holders for various roofing types
- Conventional insulated lightning protection
- Insulated isCon® lightning protection system
- Conductor brackets
- Round and flat conductors
- Connection clamps and connection terminals

Our products are available in four different materials:

- Steel, hot-dip galvanised
- Copper
- Aluminium
- Stainless steel



## Four steps to the comprehensive protection of PV systems

### Step 1

#### Check the separation distance

If the required separation distance cannot be complied with, then the metallic parts must be interconnected to be able to carry lightning current.



### Step 2

#### Check the protection measures

Measures for lightning protection equipotential bonding are used on the DC and the AC side, e.g. lightning current arrester (type 1).



### Step 3

#### Include data cables

Data cables must be included in the protection concept.











### Step 4

#### Carry out the equipotential bonding

Local equipotential bonding must be provided on the inverter.





Overview of protection measures					
Initial situation	Measure	Separation distance according to DIN EN 62305 maintained	Equipotential bonding	Surge protection	Sample product image
<p>External lightning protection system (according to DIN EN 62305)</p> 	<p>Adapt the lightning protection system according to DIN EN 62305</p>	Yes	Min. 6 mm <sup>2</sup>	DC: Type 2 V20-C 3PH-1000 5094608	
				AC: Type 1+2 V50 3+NPE 5093526	
		No	Min. 16 mm <sup>2</sup>	DC: Type 1+2 V-PV-T1+2-1000 5094230	
				AC: Type 1+2 V50 3+NPE 5093526	
<p>No external lightning protection system, earthing cable connection</p> 	<p>Requirements testing: LBO, VdS 2010, risk analysis, etc.</p>	-		DC: Type 2 V20-C 3PH-1000 5094608	
				AC: Type 2 V20 3+NPE 5095253	



# Planning process

Different planning processes can be used for positioning the air-termination rods: The protective angle method and the rolling sphere method. On the following pages, we present these to you in detail.

## Protective angle method

Using the protective angle method is only advisable in simple or small buildings and for individual building sections. It should therefore only be used where the building is already protected with air-termination rods whose positions were determined using the rolling sphere or grid method. The protective angle method is well suited for positioning air-termination rods providing merely additional protection for a small number of protruding building parts or structures. All roof structures must be protected with air-termination

rods. Here, it is necessary to observe the relevant separation distance (s) between earthed roof structures and metal systems. If the roof structure has a conductive continuation into the building (e.g. a stainless steel pipe with a connection to the ventilation or air-conditioning system), then the air-termination rod must be erected at the separation distance (s) from the object to be protected. This distance safely prevents arcing of the lightning current and dangerous spark creation.

- $\alpha$  Protective angle
- S Separation distance

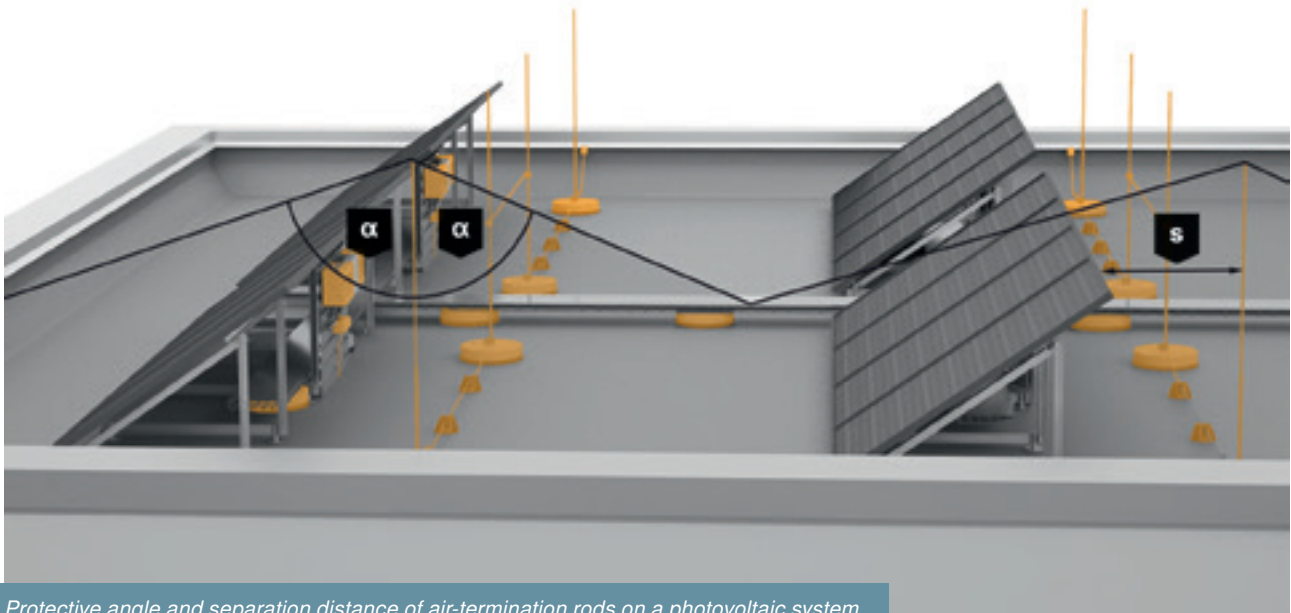

*Protective angle and separation distance of air-termination rods on a photovoltaic system*





The protective angle ( $\alpha$ ) for air-termination rods varies according to the lightning protection class. You can find the protective angle ( $\alpha$ ) in the table below for the most common air-termination rods of up to 2 m in length.

The structure to be protected (e.g. building part or device) must be fitted with one or several air-termination rods in such a way that the structure fits fully underneath a cone sheath formed by the tips of the air-termination rods and whose top angle is taken from the table. The areas bordered by the horizontal plane (roof surface) and the areas enclosed by the

cone sheath can be considered protected areas. Should the height of the roof object to be protected be known, then the formula

$$r_z = (h_1 - z) \times \tan(\alpha)$$

can be used to determine the protection area of the air-termination rod or a formula conversion can be used to determine the required air-termination rod length.

- α** Protective angle
- 1** LPZ 0<sub>A</sub>: Danger posed by direct lightning strikes
- 2** LPZ 0<sub>B</sub>: Protected from direct lightning strikes but at risk
- 3** h<sub>1</sub>: Air-termination rod height
- 4** r<sub>z</sub>: Radius of the protected area
- 5** Z: Height of the protected area

Lightning protection class	Protective angle α for air-termination rods up to 2 m in length
I	70°
II	72°
III	76°
IV	79°

Protective angle according to lightning protection class according to VDE 0185-305-3 (IEC 62305-3) for air-termination rods up to 2 metres in length

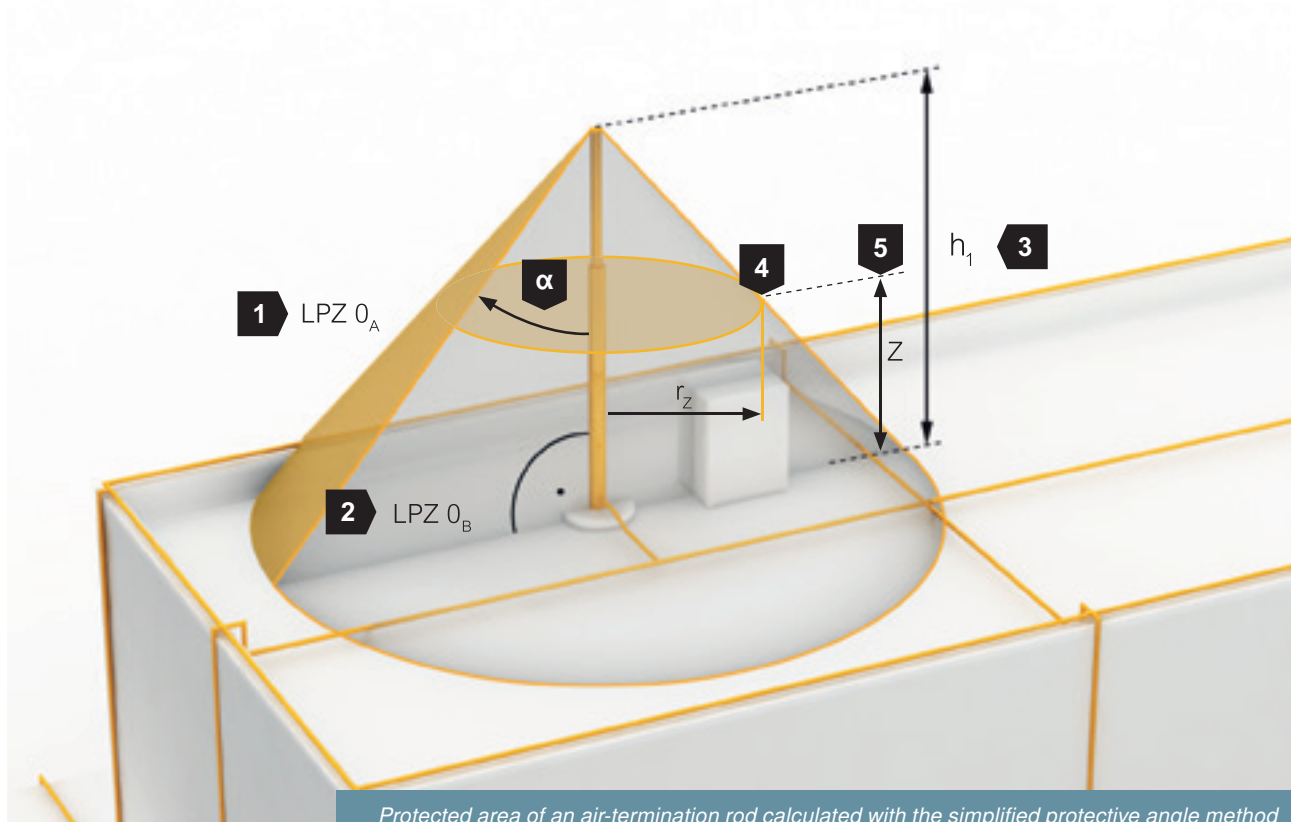

Protected area of an air-termination rod calculated with the simplified protective angle method



## Rolling sphere method: Roof structures with multiple air-termination rods

If you use several air-termination rods to protect an object, you must take into consideration the penetration depth between them. For a brief overview, see the table below or, to calculate the penetration depth, use the following formula:

$$p = r - \sqrt{r^2 - \left(\frac{d}{2}\right)^2}$$

- p** Penetration depth
- r** Radius of rolling sphere
- d** Distance of air-termination system

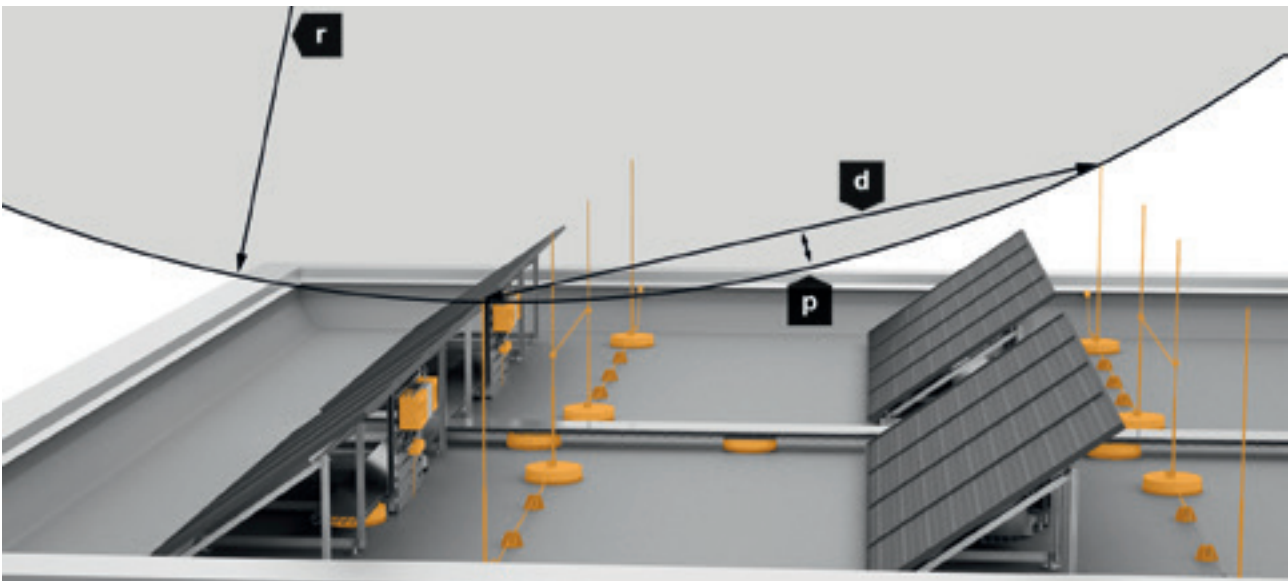

Distance of the air-termination system (d) in m	Penetration depth lightning protection Class I Rolling sphere: r=20 m	Penetration depth lightning protection Class II Rolling sphere: r=30 m	Penetration depth lightning protection Class III Rolling sphere: r=45 m	Penetration depth lightning protection Class IV Rolling sphere: r=60 m
2	0.03	0.02	0.01	0.01
3	0.06	0.04	0.03	0.02
4	0.10	0.07	0.04	0.04
5	0.16	0.10	0.07	0.05
10	0.64	0.42	0.28	0.21
15	1.46	0.96	0.63	0.47
20	2.68	1.72	1.13	0.84

Penetration depth (p) according to the lightning protection class according to VDE 0185-305 (IEC 62305)



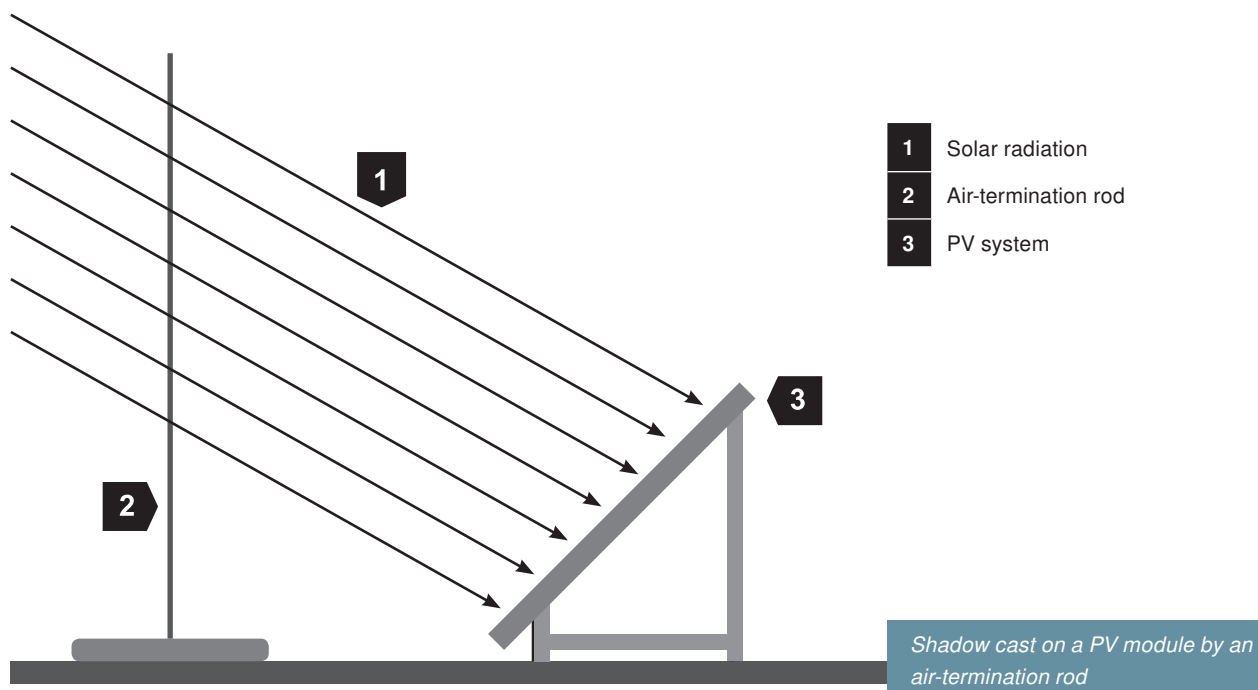

## Avoid shade from the lightning protection system

The position of the air-termination rods should be chosen so that there is no shading of the PV modules. This is because a core shadow can cause performance reductions of the whole string. For this reason, an air-termination rod must be

at least 108 x diameter from the PV module (DIN EN 62305-3 Suppl. 5). Please note that the PV system must remain in the protection area of the air-termination rod.

Diameter of the air-termination system (m)	Distance between the air-termination system and the PV module (m)
0.008	0.86
0.010	1.08
0.016	1.73

*Minimum distance from the air-termination systems, to avoid a core shadow*





## The safe solution: OBO isCon®

The separation distance can be maintained safely using the high-voltage-resistant, insulated isCon® system from OBO. The insulated isFang air-termination systems with the isCon® conductor are tested according to VDE V 0185-561-8 (IEC TS 62561-8) and, with correct planning, can minimise shading. This increases the cost-effectiveness of the entire system.

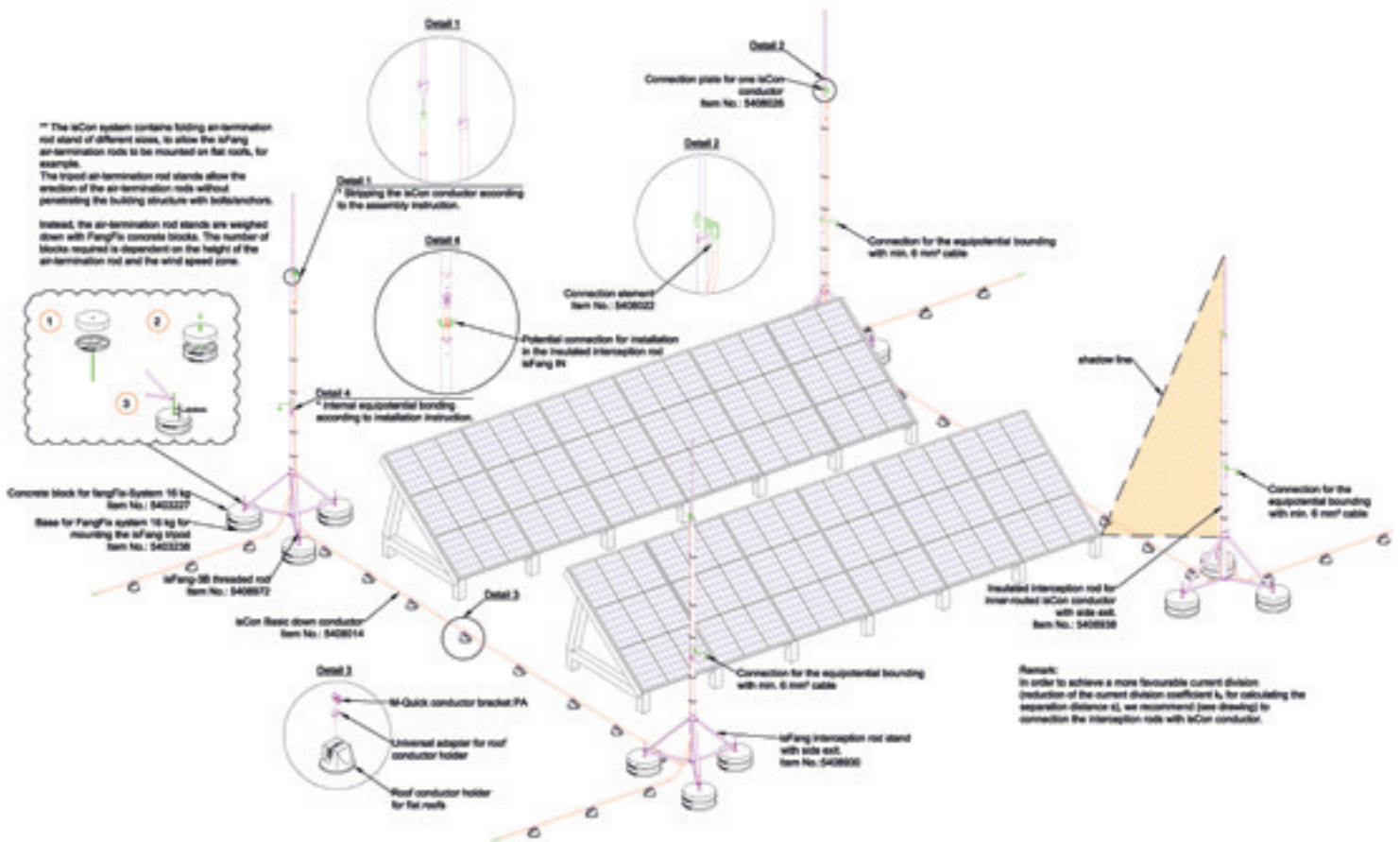

Example of a planned, insulated lightning protection system with isCon®

## Selection of protection measures

According to DIN EN 62305-3 Suppl. 5 (VDE 0185-305-3 Suppl. 5):2014-02

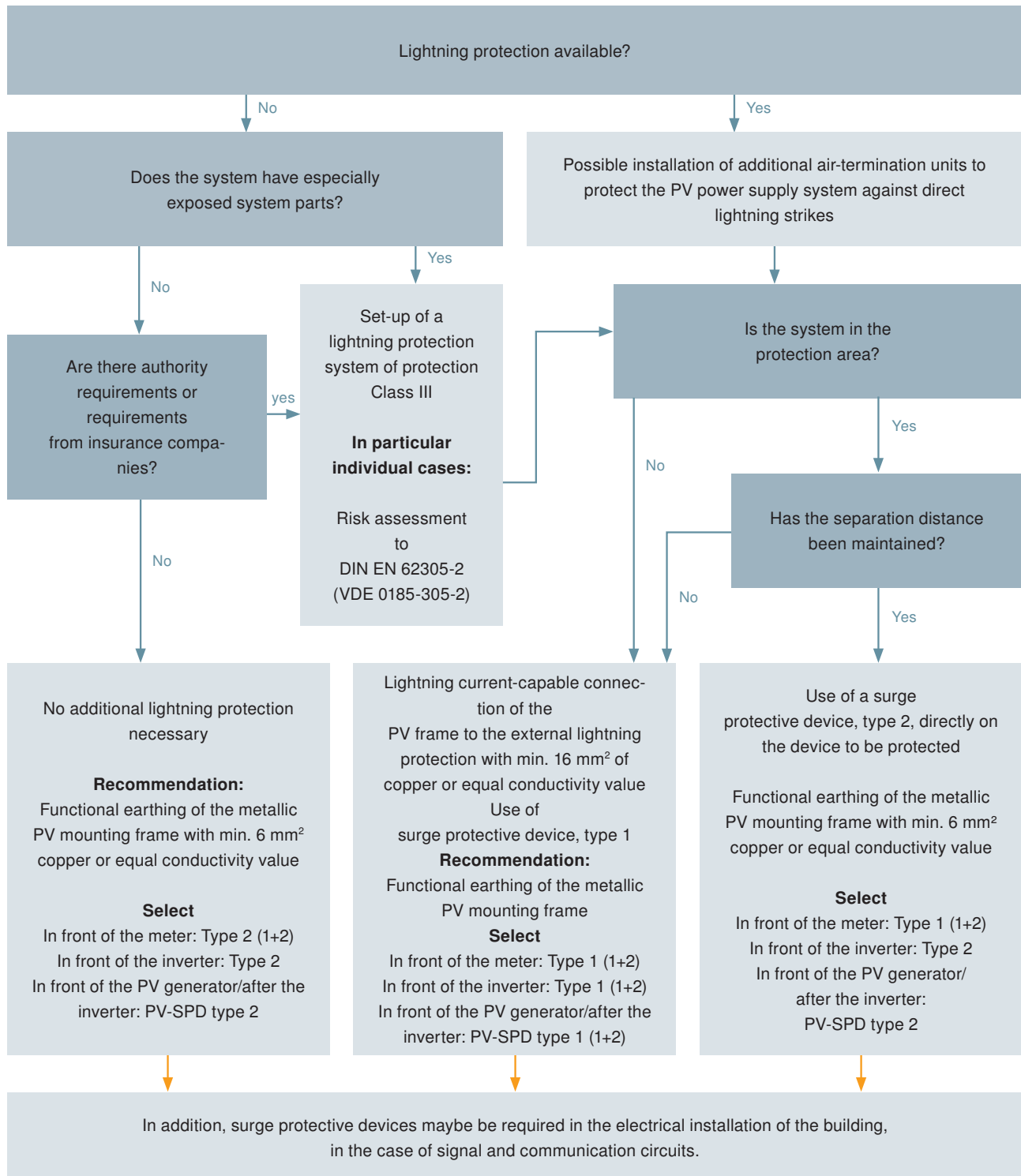

### Relevant standard

- VDE 0185-305-1 to -4 (IEC 62305-1 to -4)

*This data makes no claim to completeness! Please observe the appropriate local and statutory requirements.*

# Protection in every direction



There are always two sides to the surge protection of PV systems. Both on the direct current side (DC) and on the alternating current side (AC), surge voltages can be coupled into the system for all kinds of reasons and, for example, damage the inverter. OBO surge protection reliably protects every side. Existing data cables can be safely included in the equipotential bonding using suitable protective devices.



## The complete range

OBO's surge protection programme is set up in modules and offers solutions for almost all application cases:

- Lightning arresters
- Combined arresters
- Surge protection for information and data technology
- Combination and surge arresters for photovoltaics, DC side
- Complete system solutions, terminated and pre-mounted in the housing

The ready-made photovoltaic systems for the most common requirements are particularly useful, as they demand only minimal installation. Do you require special solutions, such as insulators or fuses? Please get in touch with us.

# Elementary for effective lightning protection



In Germany, a foundation earth electrode complying to DIN 18014 must be installed for new buildings with rooftop PV systems without a lightning protection system. In the case of on-roof PV systems with a lightning protection system, the requirements of VDE 0185-305-3 (IEC/ EN 62305-3) must be taken into account (earthing resistance  $< 10 \text{ Ohm}$ ). With free-standing PV systems, the requirements of VDE 0185-305-3 (IEC/EN 62305-3) must also be taken into account. Here, a distinction between two earthing types must be made.



## Earthing systems, type A

Type A earthing systems include, for example, screw and ram foundations if they correspond to the requirements of VDE 0185-561-2 (IEC/EN 62561-2). Here, not only a minimum cross-section must be maintained according to the selected material, but also mechanical and electrical properties as well.

## Earthing systems, type B

Plate and strip foundations function as type B earthing systems. According to VDE 0185-305-3, Supplement 5, they have a reduced earth electrode effectiveness and should be expanded using additional earthing measures such as mesh earth electrodes (20 m x 20 m) or earth rods.



For both cases, OBO's portfolio contains suitable earth rods with  $\varnothing$  20 mm or  $\varnothing$  25 mm and wires of  $\varnothing$  10 mm, as well as strips of various dimensions, such as 30 x 3.5 mm or 40 x 4 mm.

In the case of foundations with reinforcement steel, a tin-plated or copper-plated earth electrode in the earth is not permitted. In the earth, a high-alloy V4A stainless steel with a molybdenum content of at least 2%, such as those in the material nos. 1.4401, 1.4404 or 1.4571, must be used. This is primarily neutral towards other, more or less precious materials, thus guaranteeing a high system availability.

## Protective equipotential bonding of metallic substructures

To guarantee protective equipotential bonding of metallic substructures or module underframes that complies with E DIN VDE 0100-712, the following situations are categorised in VDE 0185-305-3, Supplement 5:

Situation	Minimum cross-section, copper functional earthing
PV system without lightning protection system or PV system with lightning protection system and the separation distance is maintained	6 mm <sup>2</sup>
PV system with lightning protection system and the separation distance is not maintained	16 mm <sup>2</sup>

# Plan the distance, increase the protection



*Insulated lightning protection with OBO isCon® to maintain the separation distance®*

The physical distance of a PV system to the external lightning protection system should be maintained as much as possible, in order to protect it. The typical values are between 0.5 m and 1 m. If this is not possible due to local circumstances, then the necessary distance may be undershot if the system is included in the external lightning protection system or an insulated system is created, e.g. with the high-voltage-resistant, insulated isCon® conductor.

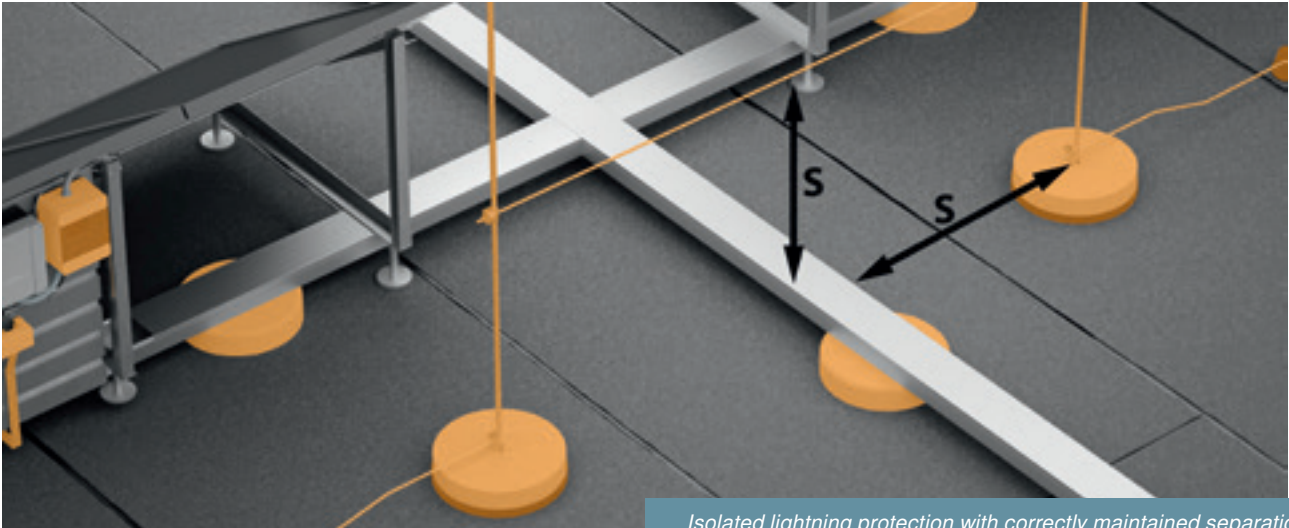

Isolated lightning protection with correctly maintained separation distance (s)

### The decisive factor: The separation distance (s)

If there is an adequate distance between the conductor through which the lightning current flows and the metallic building parts, the risk of flashover, e.g. on the supply lines to the inverter, is virtually eliminated. This distance is described as the separation distance (s).

**The separation distance (s) does not prevent inductively coupled surge voltages!**

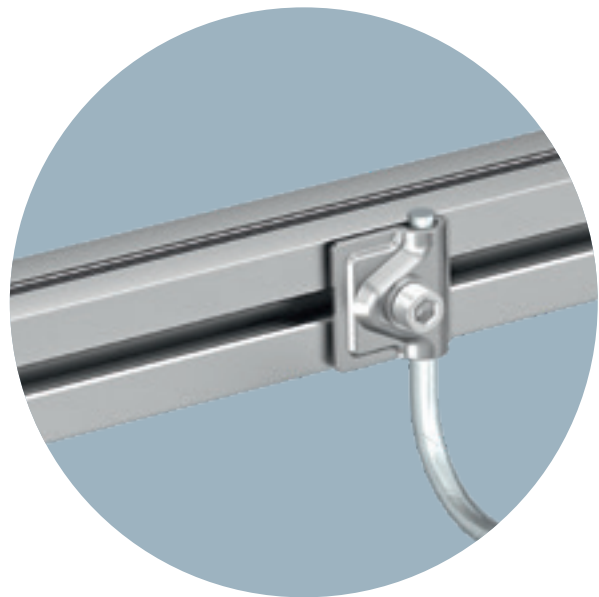

Lightning protection equipotential bonding system on PV mounting system

$$s = k_i \frac{k_c}{k_m} L(m)$$

Formula for calculating the separation distance

$k_{is}$	Dependent on the selected protection class of the lightning protection system
$k_c$	Dependent on the (partial) lightning current that flows in the conductors
$k_m$	Dependent on the material of the electrical insulation
L (m)	Vertical distance from the point at which the separation distance (s) is to be calculated up to the closest point of the equipotential bonding



Lightning protection conductor on a rainwater downpipe



Direct connection of the PV mounting frames to the lightning protection system

## If the separation distance cannot be maintained

If the separation distance according to VDE 0185-305-3 (IEC/ EN 62305-3) cannot be maintained for construction reasons, then the PV system must be connected to the lightning protection system using tested components with 16 mm<sup>2</sup> CU or 50 mm<sup>2</sup> aluminium (RD8).

Lightning protection components for connection must be tested according to VDE 0185-561-1 (IEC/ EN 62561-1). In these cases, type 1 (Class I) surge protective devices or combination arresters of type 1+2 (Class I+II) are required on the DC side, as lightning currents cannot be managed within buildings.

The necessary lightning protection equipotential bonding achieved in this way connects all the metallic and electrically conductive components of the system, including the earthing system, with the standardised lightning protection system. According to VDE 0185-305 Parts 3 and 4 (IEC/ EN 62305-3, -4), surge protective devices (SPDs) of type 1 (Class I) or combination arresters of type 1+2 (Class I+II) must be used for the cables running into the building. This applies both on

roofs and on the ground, and for the AC and the DC side of the PV power supply system. Of importance for the question regarding the necessity of surge protection measures are DIN VDE 0100-443 (VDE 0100-443) and DIN VDE 0100-712 (VDE 0100-712).



SPD type 1+2 for the PV DC side



## **Metallic building components and external lightning protection**

A separation distance does not have to be observed in buildings with cross-connected, durable walls and roofs or with cross-connected metal facades and metal roofs. Metallic components with no conductive lead into the building to be protected, and whose distance to the conductor of the external lightning protection system is less than one metre, must be connected directly to the lightning protection system. These include, although are not limited to, metallic railings, doors, pipes (with non-flammable and/or explosive contents) and facade elements.



# Solid connections, easy installation



Cables outside the building are particularly exposed to the weather. Rain, snow, heat, UV radiation and wind continually attack the PV system. OBO cable support systems combine the best possible protection with rapid mounting. Our product range comprises closed cable tray systems, wide span tray and mesh cable tray systems, and cable ladders. Using clever details, such as the mounting adapter, you can fix mesh cable trays to the OBO FangFix concrete blocks and the OBO UniBase system in a single action. Wind load securing is optional and can be implemented using OBO tightening straps. This must be tailored to the specific project as it varies, for example, depending on the local wind load.

## Cable support systems: Quickly mounted and safe

- Cable trays
- Mesh cable trays
- Cable ladders
- Vertical ladders
- Suspended supports
- Wall and support brackets

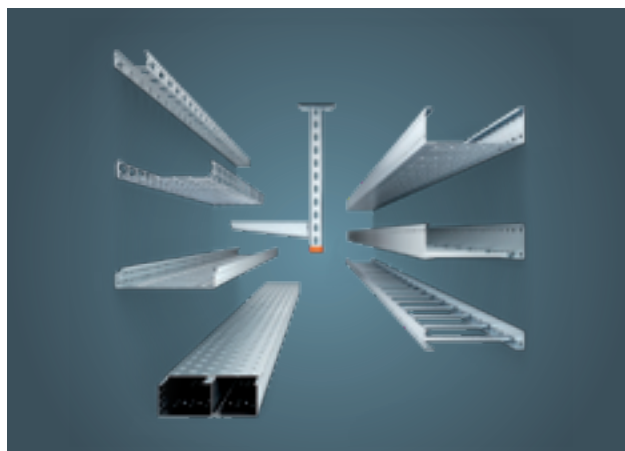

## Shielding of cables

The passive shielding of cables with OBO cable support systems with covers permits attenuation of up to 60 dB. This means that electronic system components are protected against electromagnetic interference, and economic losses through failure or damage are prevented.

## Area shielding

Direct and local lightning strikes create a magnetic field which causes induced currents in electrical and electronic systems. Professional cable routing with the OBO TrayFix systems or the OBO UniBase system can, under certain conditions according to VDE 0185-305-4 (IEC / EN 62305-4), reduce the necessary surge protection measures. The same applies to optimised cable shielding, for example with EMC-tested cable support systems from OBO.



## Strain relief for vertical cable routing

When cables are routed vertically, appropriate strain relief must be ensured. Our product range comprises vertical ladder systems with various profiles for direct wall mounting, for free-standing mounting or mounting on existing steel structures.



## Perfect protection in buildings

Even in buildings, cables are subject to mechanical loads, which, in the worst-case scenario, can lead to the failure of the system. The combination of the OBO products creates reliable protection of cabling, from the roof through to the inverter. Wall and ceiling ducts of different dimensions are complemented with appropriate fittings. Plastic and metal cable and pipe fastening systems and clips protect small cable volumes and individual cables. In this way, you can protect the system against failure through torn or worn-through cables for decades to come.



### For tidy cable routing in buildings:

- Wall and ceiling ducts
- Cable and pipe fastening systems made of plastic and metal
- Screw-in and knock-in systems
- Rail systems





*Metal pipe systems: The first choice for protection under tough conditions*



*Pre-marked openings to minimise condensation through temperature variations*

## Precautions for water removal

According to DIN VDE 0100-520 (Erection of power installations with nominal voltages up to 1,000 V) "Measures must be taken for water drainage, if water or condensation can occur within cable systems."

## Protection against sunlight and high temperatures

Strong UV radiation can cause damage and destruction to plastics. Electrical devices generate heat through power loss. In conjunction with high ambient temperatures and direct sunlight, the internal temperature can increase. Based on the local loads, the installation engineer may need to perform additional measures. For example, the installation must be protected by an additional roof against direct sunlight and loads from rain and snow.

# Cable routing over firewalls

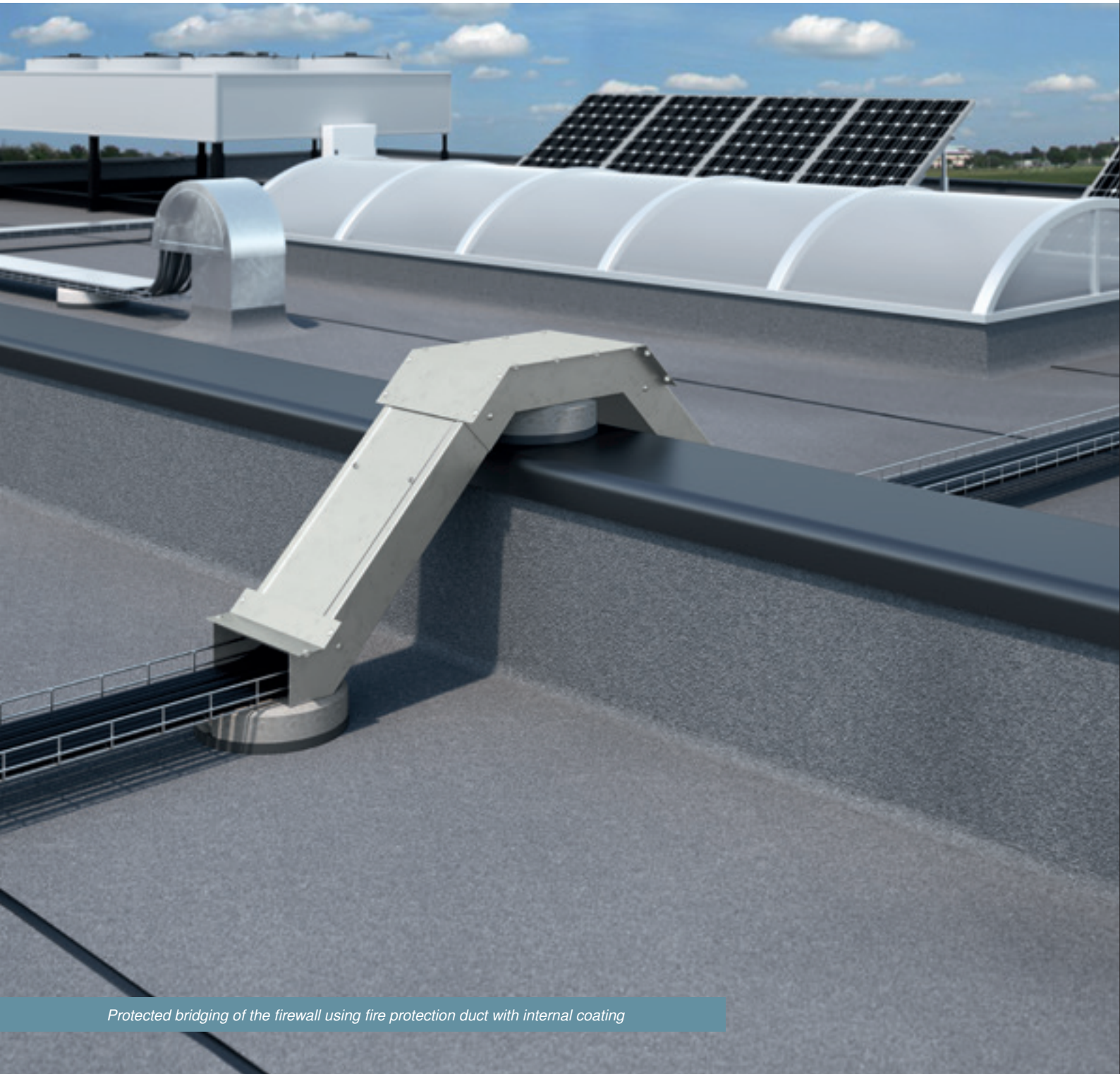

*Protected bridging of the firewall using fire protection duct with internal coating*

Combustible cables may not be run over firewalls without fire protection measures. This is because, in the event of fire, they would spread the fire to the neighbouring roof area.

Two solutions are available to bridge firewalls in a protected manner, thus preventing fire spread:

- Routing of the PV cables in extremely robust PYROLINE® PLMR stainless steel duct
- Wrapping of the cable bundles with the flexible, weatherproof PYROWRAP® Wet FSB-WB cable bandage

When there is a fire, the substances forming an insulation layer, which are contained in both solutions, foam up and prevent the spread of fire via the PV cables.



*Fire protection bandage to prevent fire spread*

## Insulated lightning protection in a thermal insulation composite system (WDVS)

If isCon® cables are routed within a thermal insulation composite system (WDVS), then they may penetrate fire locks made of non-combustible substances. If there is a fire, the fire locks may even fail. Here, the PYROWRAP® Wet FSB-WB cable bandage is again used, which prevents the spread of the fire. Whilst the insulation burns and openings are created, the insulation layer creator foams them up again. This safely prevents a chimney effect via the isCon® conductor.

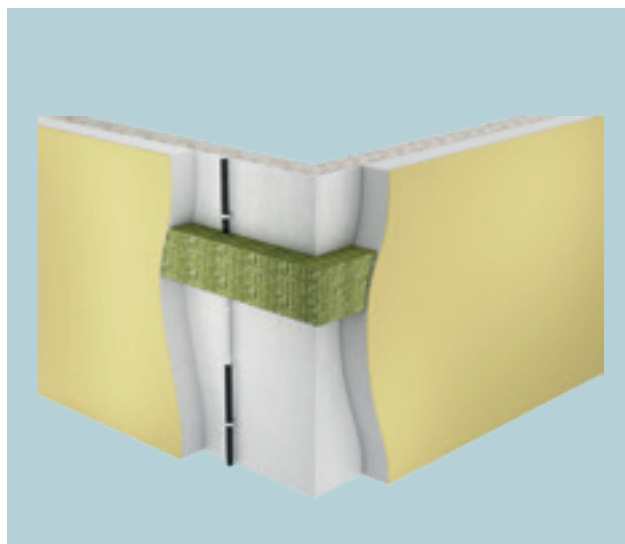

*Fire protection bandage to prevent fire spread via isCon® in thermal insulation composite systems (WDVS)*

## Routing PV cables within buildings

In some cases, the cables carrying direct current must still be routed through the building up to the inverter. If the installations are in escape and rescue routes, then the PV DC cables must be routed in encapsulated form. The OBO PYROLINE® Sun PV fire protection ducts are suitable for this. They are made of non-conductive lightweight concrete and fulfil the construction requirements as installation ducts with proven fire protection. In addition, the fire protection duct fulfils the requirements of the application rule VDE-AR-E 2100-712 for fireproof and contact-proof installations (Sections 6.2 and 6.4). This also offers additional protection for the rescue services against electric shocks during extinguishing work.

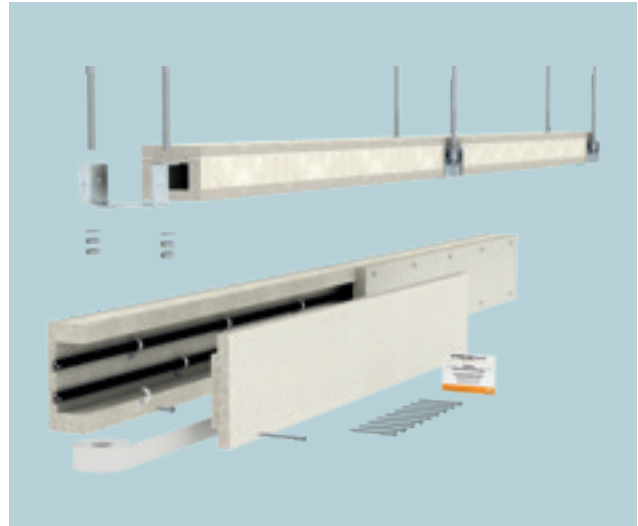

PYROLINE® Sun PV fire protection ducts for cable routing in escape and rescue routes

## Protection through organisational measures

At the transition point of the electrical system, e.g. house connection box, main distribution, VDE 0100-712 and VDE-AR-E 2100-712 require the attachment of the standardised information sign/fire brigade sign. The fire brigade can recognise the PV system through the identification and fireproof routing of the energised DC cables.



### Construction regulations

- EN 13501-1/-2, DIN 4102-1/-2 regulations on the flammability of building materials and building products

*The national and regional construction regulations must be observed with regard to the use of construction products. These include, for example, the state construction regulations in Germany, VKF regulations in Switzerland and OIB directives in Austria.*



## Roof hook, universal for pitched-roof systems

- For installation on all standard pitched roof types with tiled roofing
- Can be adjusted in all directions to the millimetre
- Maximum flexibility thanks to a total of 9 holes for M8 disc-head screws for mounting the roof hook on a rafter
- Quick and easy positioning (vertical and/or horizontal) of the hook with just one fastening screw
- Vertical alignment options enable easy compensation for unevenness on the roof
- The mounting rail is mounted without screws or tools, thanks to the innovative OBO Magic technology
- 14 mm height compensation for adaptation to existing roof battens
- 76 mm lateral adjustment option on the rafters
- 18 mm height compensation after mounting the roof hook and for fine adjustment of the mounting profile
- 10 mm lateral adjustment option for fine adjustment of the mounting profile



## Support profile for flat- and pitched-roof systems

- Black version for seamless and attractive adaptation to the conditions of the individual roof covering
- Double-sided 10 mm-wide grooves, e.g. for sliding nuts, universal and/or earthing terminals
- Other lateral grooves, e.g. for straight and/or cross-connectors

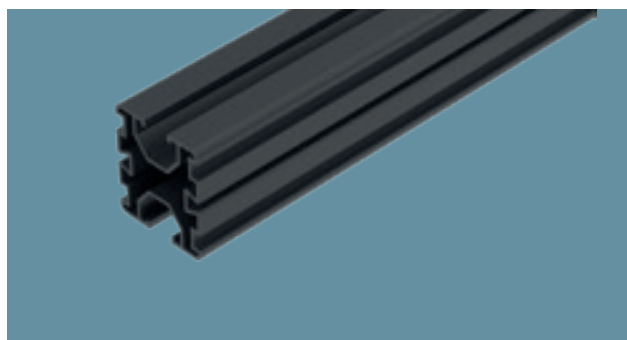

## Universal terminal for flat- and pitched-roof systems

- Black version for seamless and attractive adaptation to the conditions of the individual roof covering
- Double-sided 10 mm-wide grooves, e.g. for sliding nuts, universal and/or earthing terminals
- Other lateral grooves, e.g. for straight and/or cross-connectors



## Universal base UniBase 10

- Low weight in direct comparison to a TrayFix block
- Components can be stacked on top of each other
- Simple alignment through subsequent weighting
- Mounting without tools for different types of adapters
- Recyclable material
- Can be ballasted with standard paving stones 200 x 100 mm (to be purchased locally)
- A UniBase for various applications, such as sub-structure, cable routing, mounting rails and much more
- 2 variants available in the heights 60 and 100 mm

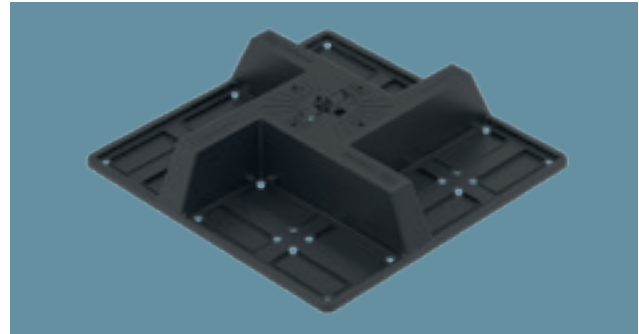

## Support profile for flat- and pitched-roof systems

- Plain version for all roofs without specific aesthetic requirements
- Double-sided 10 mm-wide grooves, e.g. for sliding nuts, universal and/or earthing terminals
- Other lateral grooves, e.g. for straight and/or cross-connectors

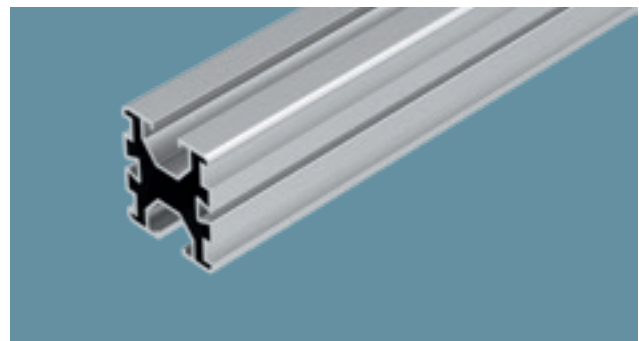

## Support, short for flat-roof systems

- Installation on the mounting rail without tools
- Continuous adjustment options in every installation position
- Auxiliary bracket for mounting the solar module
- Horizontal slot for universal terminal as a standard fastening or vertical slot if a single mounting foot is also used as an intermediate support
- An intermediate support for each panel is possible, if required
- Compatible with all module sizes thanks to the angled joint head
- Long service life thanks to the high-quality surface coatings



## Universal clamp for flat- and pitched-roof systems

- Plain version for optimal combination with plain support profile
- Clamping range for module fastening from 30 to 50 mm
- Can be rotated by 90° after engaging in the mounting rail groove
- Can be used as an connection or end clamp
- Specific geometry at the corners of the upper part for equipotential bonding to the solar module
- Plastic housing guides the upper part and prevents it from twisting incorrectly during mounting
- The upper part remains in its upper position until the solar module is fixed in place
- Can be clicked onto the provided mounting feet (flat-roof system) and into the mounting rail groove (pitched-roof system)
- Plastic housing functions as a support surface to position the panels correctly
- Long service life thanks to the use of high-quality stainless steel

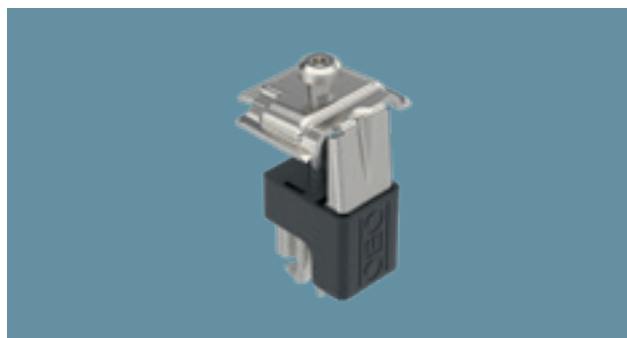



## Pre-mounted support for free-standing systems

- System components pre-mounted at the factory reduce the amount of installation work required on-site
- Supports are unfolded on-site, attached to the anchored or rammed profile and fixed in place using the appropriate fastening material
- Cross-bracing provides additional support for the entire system
- Many different variants available, depending on the tilt angle and size of the PV modules used



Available on request.

## Stand for concrete foundation

- Anchored variant, e.g. for concrete substrates
- Stable connection technology, e.g. through the use of wedge anchors
- The pre-mounted supports are mounted with easy-to-use screw fastenings

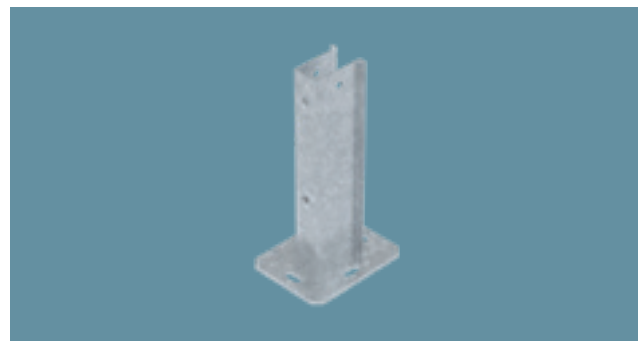

Available on request.

## End clamp for free-standing systems

- The PV module is fixed using a pre-mounted fastening screw
- Many different variants available, depending on the frame height of the PV modules used
- In addition to end clamps, the OBO product range also includes corresponding connection clamps



Available on request.



Pitched-roof system



Flat-roof system



Free-standing system

## Conductor bracket for Rd 8 mm, through-way Ø 5 mm

- With M6 internal thread or Ø 5 mm through-way hole
- Made of rustproof stainless steel (V2A)



## ALU Vario Quick connector

- For T, cross and parallel connections

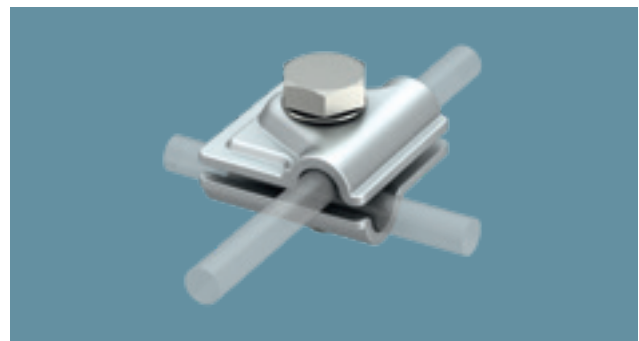

## Pipe air-termination rod, tapered

- Suitable for wind loads according to Eurocode 1



## isCon® conductor, black

- High voltage-resistant, insulated conductor
- To maintain the separation distance according to IEC 62305 (VDE 0185-305-3)
- Tested according to IEC/EN 62561-1 (VDE 0185-561-1) with H1/150 kA
- Various versions available



## Connection element for installation in the isFang IN insulated air-termination rod

- Screw-in termination of the connection for the isCon® conductor
- Connection and routing of the conductor in the insulated air-termination rod



## isCon® connection elements

- Screw-in termination of the connection for the isCon® conductor
- Including heat-shrinkable sleeve and hexagonal connection



## Insulated air-termination rod for internally routed isCon® conductor with side exit

- For mounting on the building structure with isFang support
- Suitable for wind loads according to Eurocode 1

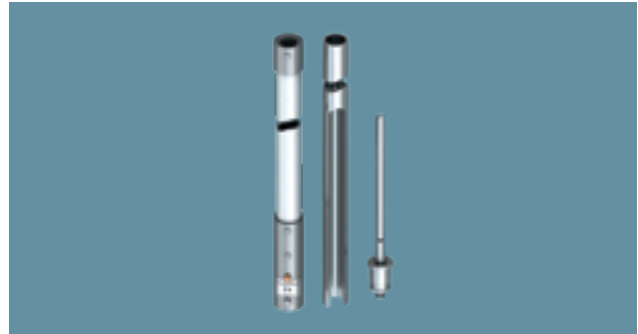

## isFang air-termination rod stand

- Installation of free-standing air-termination rods and insulated air-termination rods with 40 mm diameter
- Roof slope up to max. 5 degrees



## Rod holder, 16 mm

- For Rd 16 air-termination and earth entry rods
- With M8 internal thread or Ø 7 mm through-way hole



## V50 combination arrester and V20 surge arrester

- For lightning protection equipotential bonding
- Modular plug-in arrester



## PV complete block 1,000 V DC/1,500 V DC

- Lightning protection equipotential bonding according to IEC 62305 (VDE 0185-305)
- Surge protection according to IEC 60364-7-712 (VDE 0100-712)
- Arresting capacity up to 12.5 kA (10/350) and 40 kA (8/20)



Pitched-roof system



Flat-roof system



Free-standing system

## Surge Controller V20 2-PH-1000

- Arresting capacity up to 40 kA (8/20) per pole
- Low DC protection level: < 4.0 kV and  $U_{oc\ max} = 1,000\ V\ DC$



## LightningController MCF25-NAR-TNC/ MCF38-NAR-TNC type 1+2

- Lightning current arresting capacity up to 25/38 kA (10/350), 3-pole
- Fulfils the requirements of VDE 0100-534 (IEC 60364-5-53)
- For TN-C systems
- For 30 mm busbars
- Spark gaps for use in the pre-meter area
- According to VDE-AR-N 4100



## LightningController MCF30-NAR-TT/MCF50-NAR-TT type 1+2

- Fulfils the requirements of VDE 0100-534 (IEC 60364-5-53)
- Follow current quenching up to 50 kA and max. pre-fuse up to 160 A gL/gG
- Spark gaps for use in the pre-meter area according to VDE-AR-N 4100
- For TNS and TT systems
- For 30 mm busbars



## Combination protection device TD-2D-V for VDSL systems

- Low protection level at a high current load
- "Push-in" terminals for rapid installation



## Surge protection for high-speed networks up to 1 GBit

- Support of Power over Ethernet ++ (PoE++/4PPoE) up to 1 A according to IEEE 802.3
- Earthing via DIN rail or connection cable



Pitched-roof system



Flat-roof system



Free-standing system

## Earth rod BP

- Very good contacting properties through soft metal inlay in the drill hole
- With spigot and drill hole for arrangement
- Variant in V4A and FT

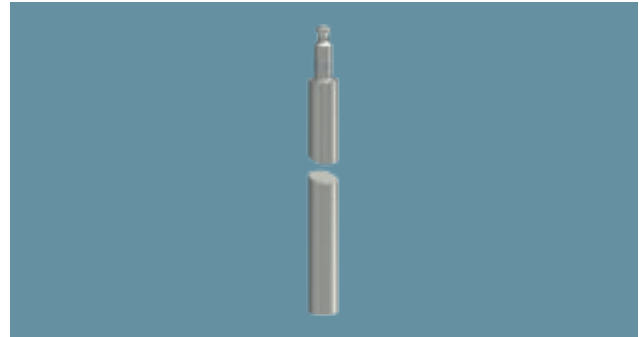

## Connection clip for earth rods, universal

- Mounted with two M10 x 30 hexagonal bolts and two M10 hexagonal nuts
- Suitable for connecting round conductors Rd 8-10 or flat conductors up to FL 40
- Variant in V4A and FT





## Round conductor, stainless steel

- RD 10-V4A for applications in the earth



## Cross-connector for stainless steel round and flat conductors

- Mounted with two M8 x 20



## Equipotential busbar for outside installation, metal base plate

- Lightning current carrying capacity 100 kA (10/350)
- Polystyrene cover hood; colour: black, UV-resistant
- Steel base plate, zinc-iron surface



## BigBar equipotential busbar for industrial areas

- With spring washer (DIN 137) for protecting screws against self-loosening
- Complete with insulation feet, anchors and screws for wall mounting

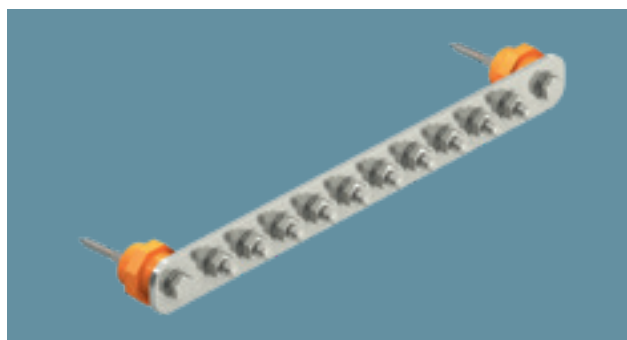

## Quick connector, upper part, Rd 8–10 mm

- For round conductor Rd 8-10
- Suitable for M10 screws

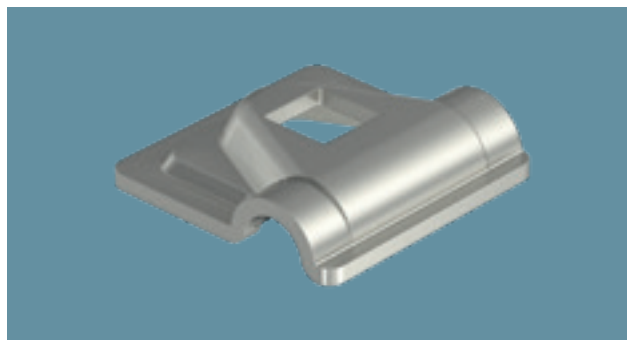

## Quick connector, upper part, Rd 8–10 mm

- For round conductor fastening RD 8-10
- Suitable for M10 screws

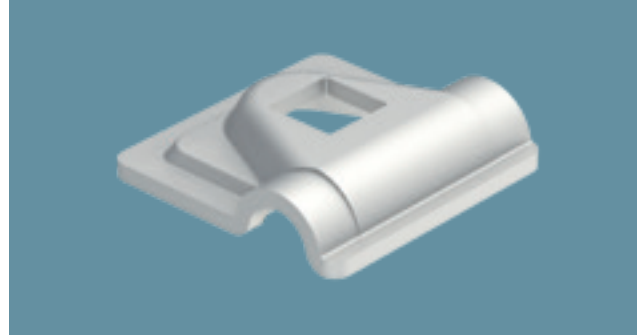

## Bridging cable

- With aluminium cable shoes
- Made of flexible, insulated copper cable 16 mm<sup>2</sup>
- Suitable for use outside or in rooms



## Mounting rail, MS4141, slot 22 mm, FT, perforated

- Heavy-duty C profile rail for individual installation of support structures
- Can also be used for cable routing, in conjunction with clamp clips with U base



## Junction box T160, plug-in seal, raised cover

- Junction box according to DIN EN 60670. Flame-resistant according to DIN EN 60695-2-11, test temperature 650°C
- Rectangular shape with plug-in seals at the sides and knock-out entries in the base
- Manufactured from halogen-free materials

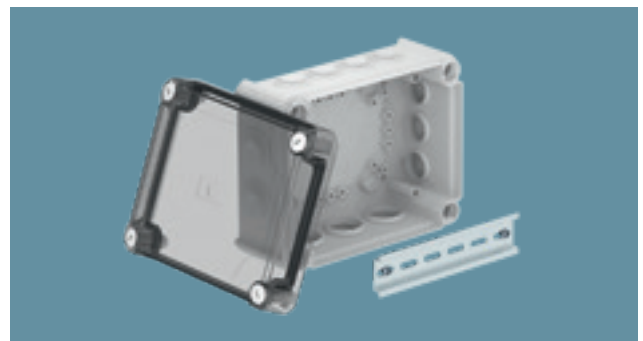

## Quick pipe, light grey

- Open plastic Quick pipe for surface-mounted routing of M16/M20 cables
- Can be used in the temperature range of -25 to +60 °C
- Toolless closing and opening through turning in the clip

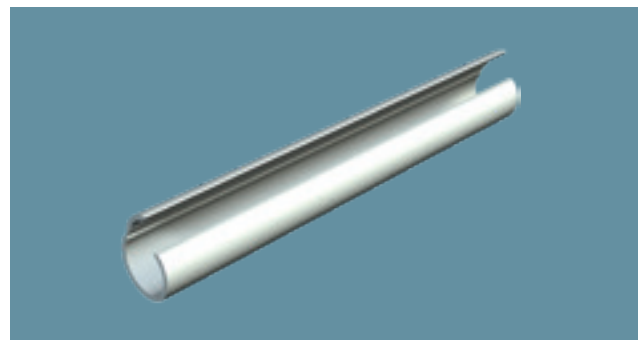

## 165 MBG... roof conductor holder for flat roofs, black, with concrete

- Closed shape with base
- With double conductor bracket
- Filling weight 1 kg (frost-resistant concrete)

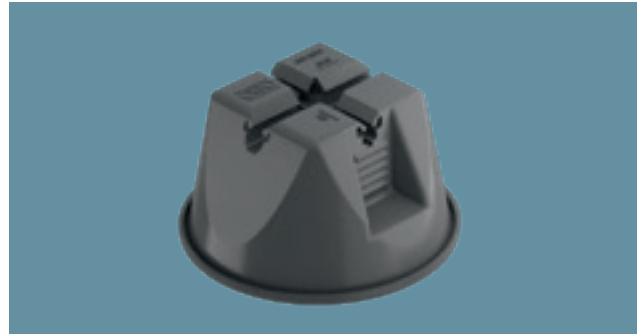

## Mesh cable tray adapter for roof conductor holder

- Adapter for mesh cable trays, type GR-Magic®, with 50 mm or 20 mm grid width
- For fastening on type 165 MBG 8-10
- Toolless mounting

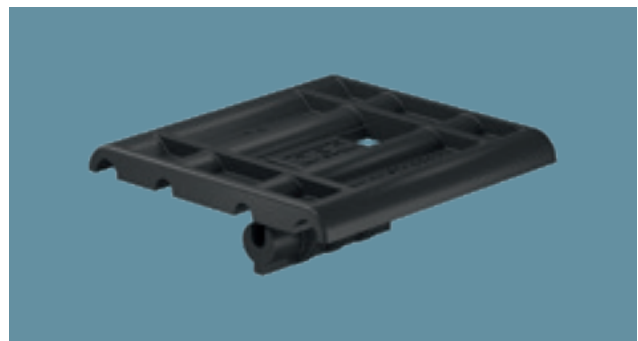

## Stand – TrayFix set 10 S

- Mounting system for the fastening mesh cable trays with the FangFix concrete block, e.g. for cable routing on a flat roof
- Adapted to OBO mesh cable systems with a minimum width of 100 mm
- Set consisting of a TrayFix mounting adapter and concrete block, incl. base for FangFix system 10 kg

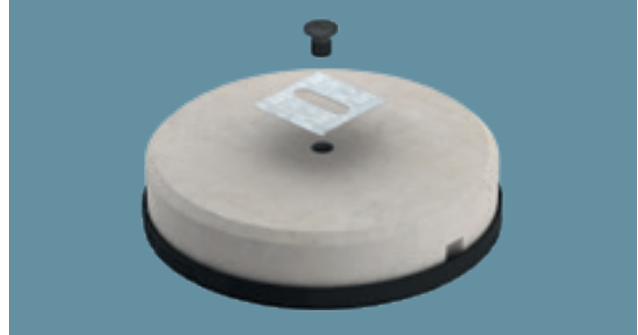

## Stand – TrayFix set 10 L

- Mounting system for the fastening mesh cable trays with the FangFix concrete block, e.g. for cable routing on a flat roof
- Adapted to OBO MKSM and SKSM cable tray systems
- Adapted to OBO mesh cable tray systems with a minimum width of 100 mm
- Set consisting of a TrayFix mounting adapter and concrete block, incl. base for FangFix system 10 kg

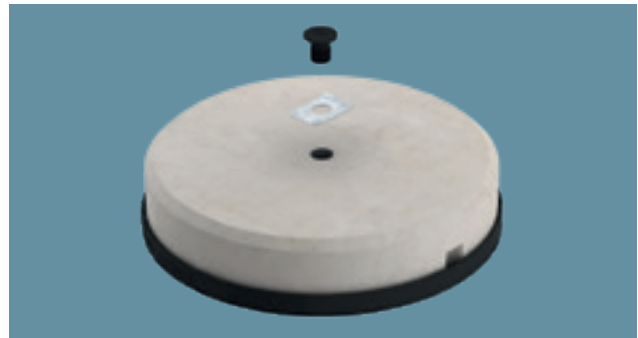

## Stand – TrayFix set 16 S

- Mounting system for the fastening mesh cable trays with the FangFix concrete block, e.g. for cable routing on a flat roof
- Adapted to OBO mesh cable systems with a minimum width of 100 mm
- Set consisting of a TrayFix mounting adapter and concrete block, incl. base for FangFix system 16 kg

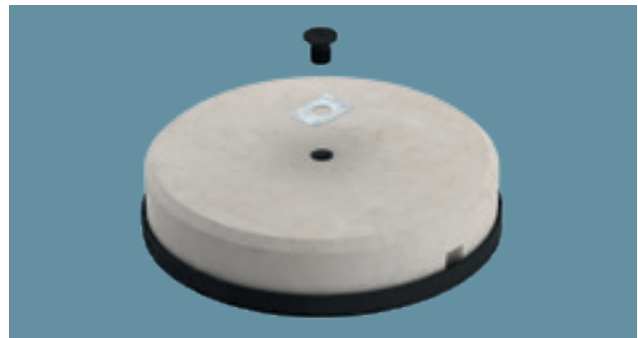

## Stand – TrayFix set 16 L

- Mounting system for the fastening mesh cable trays with the FangFix concrete block, e.g. for cable routing on a flat roof
- Adapted to OBO MKSM and SKSM cable tray systems
- Adapted to OBO mesh cable tray systems with a minimum width of 100 mm
- Set consisting of a TrayFix mounting adapter and concrete block, incl. base for FangFix system 16 kg

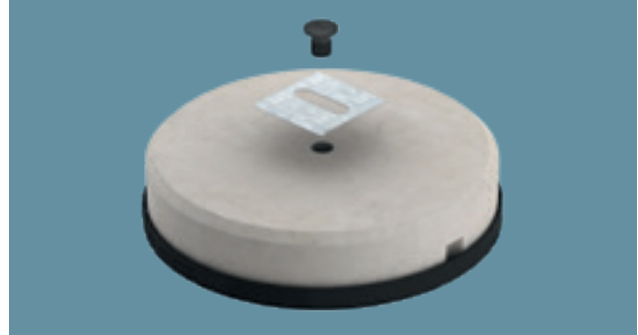

## GR-Magic® 55 FT mesh cable tray

- Magnetic shield attenuation without cover 15 dB, with cover 25 dB

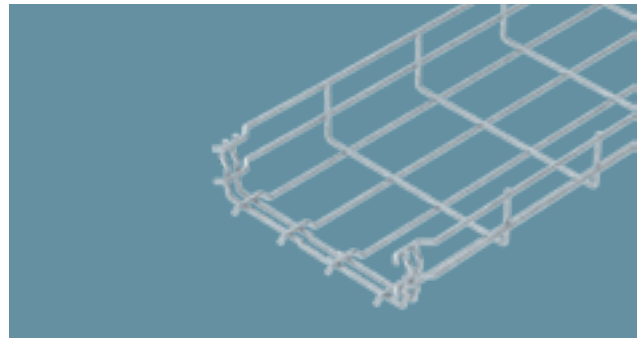

## RKS-Magic® 60 FT cable tray

- Cable tray with integrated quick fastening system. The usable length of the cable tray is 3,000 mm
- The cable tray has a continuous side perforation of 7 x 20 mm for the installation of additional connection and mounting components
- Continuous equipotential bonding is guaranteed without additional components
- Cable trays can also be fitted with a compatible cover for additional protection of cables

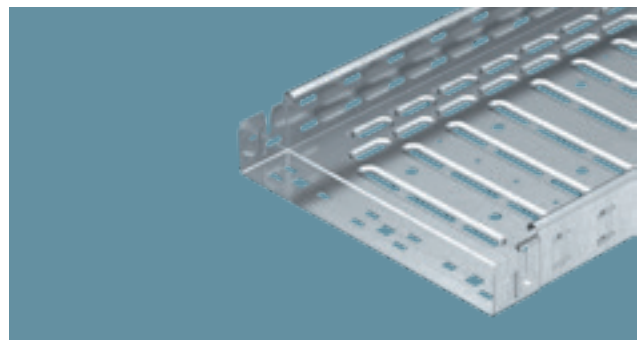

Pitched-roof system



Flat-roof system



Free-standing system

## PYROWRAP® Wet FSB-WB cable bandage for outdoor applications

- Complete set to surround cable bundles or cable support systems without covers
- The sets each contain four sections of the weather-resistant PYROWRAP® Wet cable bandage
- Length 550 mm // Width 380/880 mm

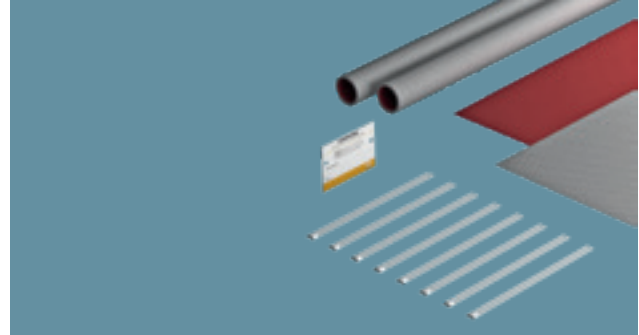

## PYROLINE® Sun PV

- Non-conductive surface
- Direct wall or ceiling mounting
- Mounting on threaded rods
- For I30 duct classified for escape routes



## PLMR metal installation duct, for outdoor applications

- Metal installation duct with intumescent fire protection mesh
- Fire resistance up to 90 minutes
- To overcome obstacles in outdoor areas with corresponding fittings
- Suitable for mounting on FangFix concrete blocks

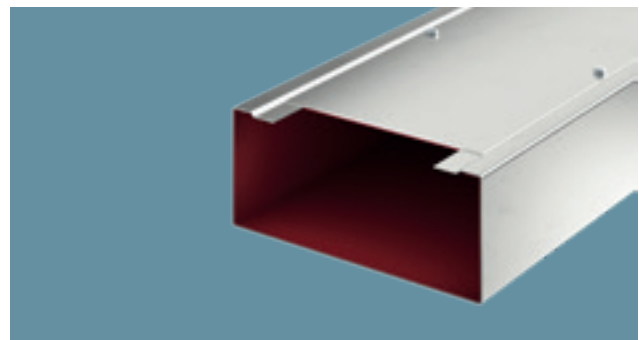





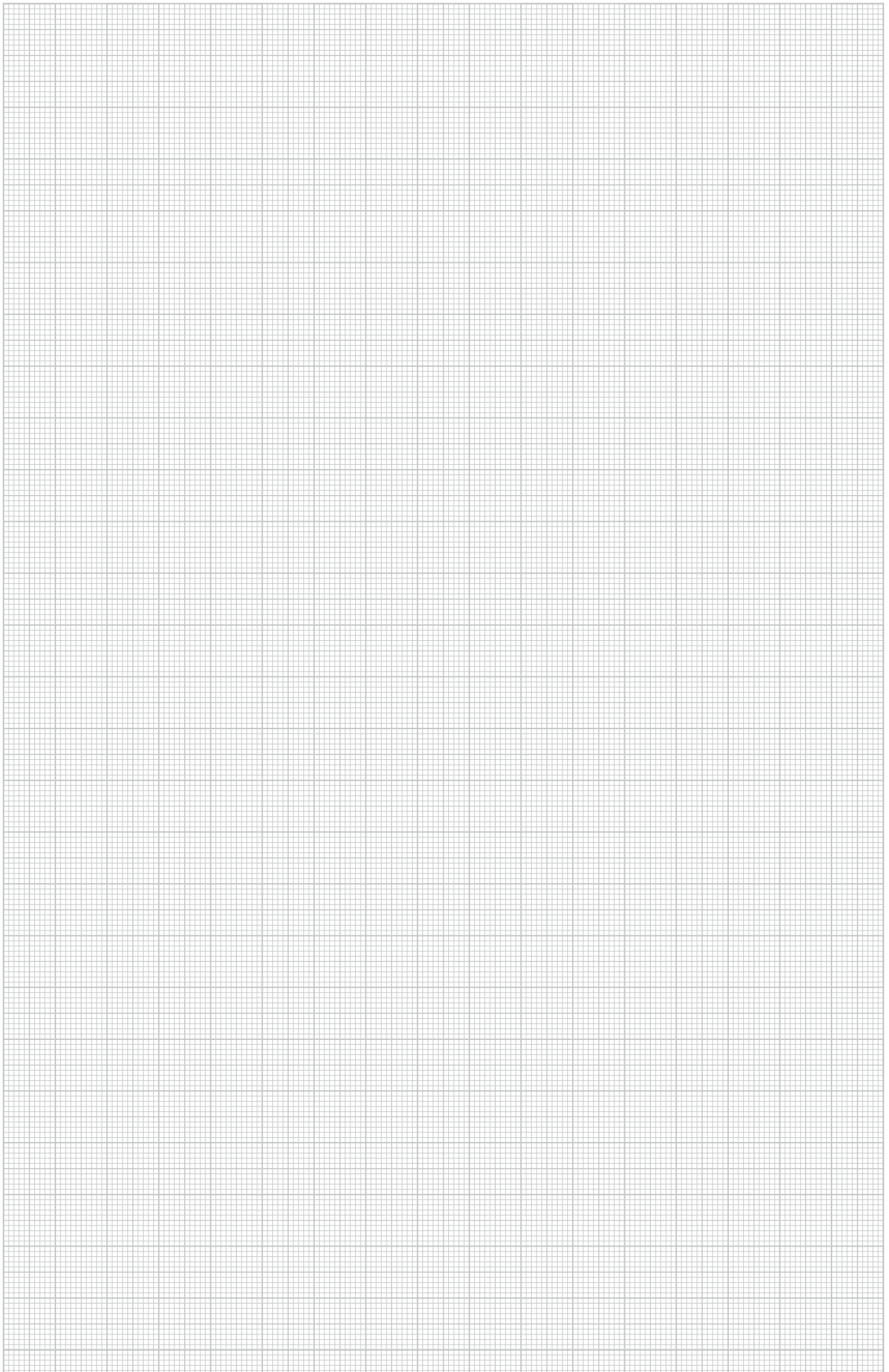

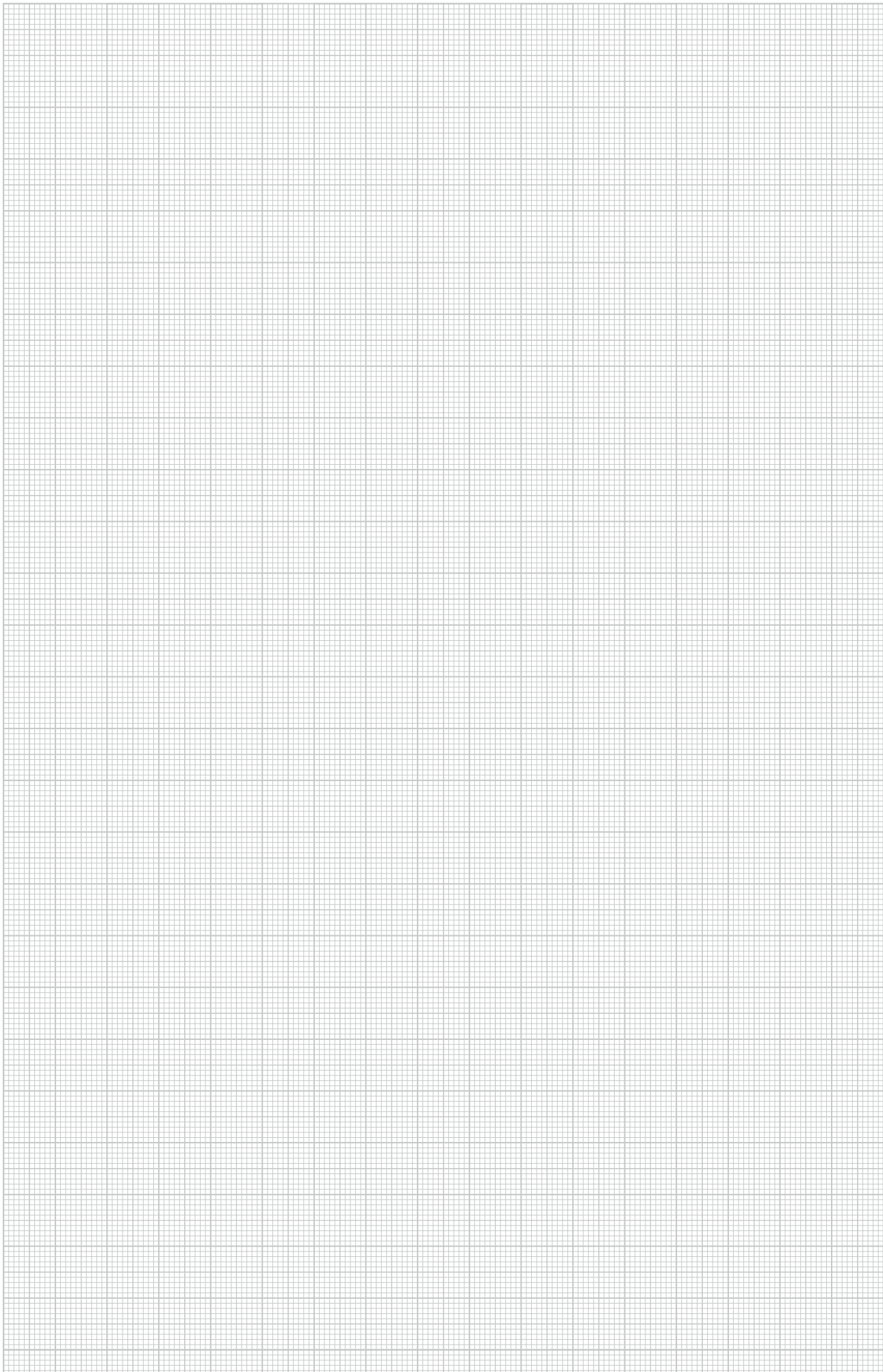

**OBO Bettermann Holding GmbH & Co. KG**

P.O. Box 1120  
58694 Menden  
GERMANY

**Customer Service**

Tel.: +49 (0)2373 89-1700  
export@obo.de

[www.obo-bettermann.com](http://www.obo-bettermann.com)

© OBO Bettermann Order no. 9196405 03/2024 EN